

# VC.3043

UHD-4k Touch screen



# Contents

- 1. UHD-4k Touch screen camera application \_\_\_\_\_ 3
- 2. Connection modes of UHD-4k Touch screen camera \_\_\_\_\_ 3
- 3. Application configurations \_\_\_\_\_ 4
  - 3.1 Standalone with built-in embedded touch/mouse driven software \_\_\_\_\_ 4
  - 3.2 Connecting to the PC with USB video interface \_\_\_\_\_ 4
- 4. Brief introduction of user interface (UI) and its functions \_\_\_\_\_ 4
  - 4.1 Embedded touch/mouse driven software UI \_\_\_\_\_ 4
  - 4.2 The camera control panel on the left side of the video window \_\_\_\_\_ 5
  - 4.3 The measurement toolbar on the top of the video window \_\_\_\_\_ 5
  - 4.4 The image adjustment toolbar at the bottom of the video window \_\_\_\_\_ 6
  - 4.5 Setting \_\_\_\_\_ 8
- 5. Sample photos \_\_\_\_\_ 12

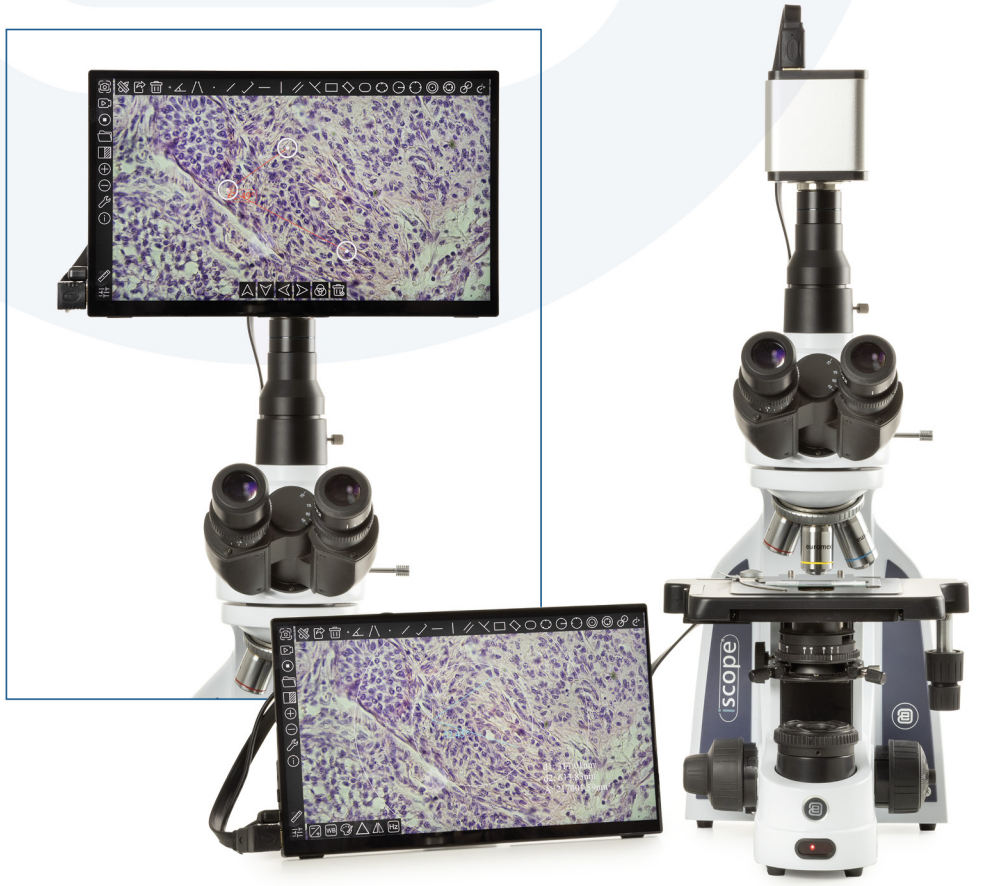

## 1. UHD-4k Touch screen camera application

The UHD-4k Touch screen camera is intended to be used for the acquisition of digital images from the stereo microscope and biological microscope. The basic characteristic is listed below:

- Sony Exmor/STARVIS back illuminated CMOS sensor
- 4K HDMI/USB multiple video outputs
- 4K/1080P auto switching according to the display resolution
- SD card/USB flash drive for the captured image and video storage, support local preview and playback
- Embedded touch/mouse driven software for the controls of the camera with touch screen or mouse
- The touch or mouse control mode can be switched
- With strong ISP and other related processing functions
- ImageFocus Alpha software for PC

## 2. Connection modes of UHD-4k Touch screen camera

The camera touch screen can be connected to the camera and placed on the photo tube of the microscope or separately from the camera to provide easy touch access (see images on previous page)

Apart from the microscope and this camera and touch screen the user only needs:

a HDMI cable, a USB type A to type C data cable, an SD card, a power adapter.

The steps to start the camera are listed as below:

- Connect the HDMI output on the camera to the touch screen, using the HDMI cable (1)
- Connect the USB interface of the camera to the touch screen with the USB type-A to type-C cable (2)
- Insert the supplied SD card into the camera SD card slot (3)
- Connect power the adapter (4) to the camera and switch it on (5)
- After startup, the touch screen will display a real-time image of the sensor. Clicking or touching the left side of the touch screen, the camera control panel will display the menu for control of the camera (see image page 4)

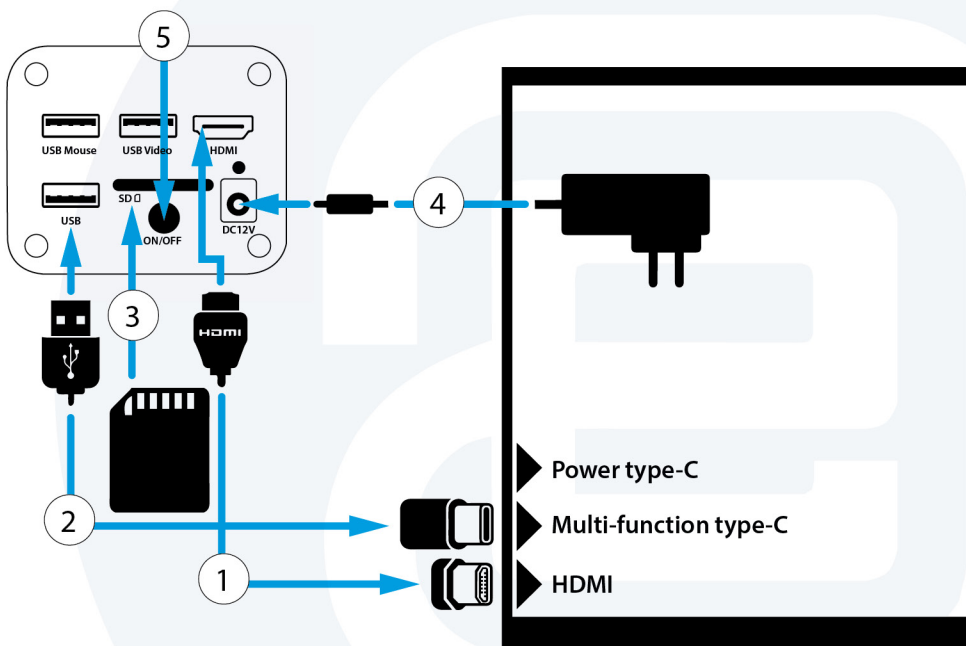

### 3. Application configurations

You can use the UHD-4k Touch screen camera in two different ways. Each application requires different hardware environment

#### 3.1 Standalone with built-in embedded touch/mouse driven software

For this application, apart from the microscope, the user needs a UHD-4k Touch screen camera, an HDMI cable, a USB Type A to Type C data cable, an SD card, a power adapter

The steps to start the camera are listed as below:

- Connect the HDMI output on the camera to the touch screen using the HDMI cable
- Connect the USB interface of the camera to the touch screen with the USB Type-A to Type-C cable
- Insert the supplied SD card into the SD card slot
- Connect power adapter to the camera the and switch it on
- After start-up, the touch screen will display real-time image of sensor. Clicking the left side of the touch screen , the camera control panel will display the control of the camera

#### 3.2 Connecting to the PC with USB video interface

The steps to start the camera are listed below:

- Install the ImageFocus Alpha on your PC
- Connect power adapter to the camera the and switch it on. After starting the camera, plug one end of the USB cable into the USB 2.0 port of the UHD-4k Touch screen camera, and plug the other end into the USB port of the PC
- Open ImageFocus Alpha software. The UHD-4k Touch screen camera will be recognized automatically by software. In ImageFocus Alpha software, select the corresponding UHD-4k Touch screen camera by clicking the camera name in the camera list







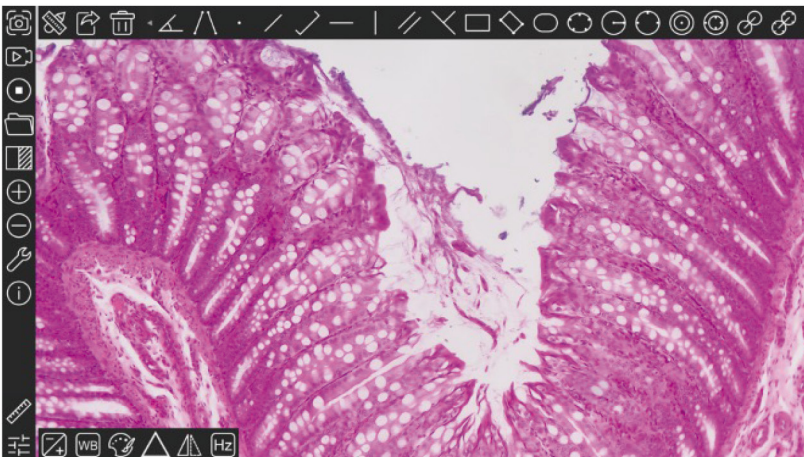

**Note:** The video output function of the USB video interface and the touch function of the USB interface cannot be used at the same time. When the camera is connected to computer and touchscreen at the same time, the USB video function will prevail, the touch function will not be available. When the USB cable is unplugged, the touch function can be used normally

### 4. Brief introduction of user interface (UI) and its functions

#### 4.1 Embedded touch/mouse driven software UI

*The UHD-4k Touch screen Camera's Control GUI*



Notes	
1	When user touches the left side of the video window, the <b>camera control panel</b> will pop up automatically Refer to Section Sec. 4.2 for details.
2	When the user touches the button -  - on the bottom-left of the camera control panel, a <b>measurement toolbar</b> -  - will be displayed above the video window for measurement and calibration. Click anywhere else in the video window to exit the measurement mode. During the measurement process, the user can slide left and right on the measurement toolbar to select the required measurement tool. When user selects a single measurement object, the <b>object position &amp; attribute control bar</b> -  - will automatically pop up at the bottom of the video window to modify the position and attribute of the measurement object. See Sec. 4.3 for details
3	When user touches the -  - button on the bottom-left of the <b>camera control panel</b> , the <b>image adjustment toolbar</b> -  - will be displayed on the bottom of the video window , which allows image adjustment operations. See Sec. 4.4 for details







## 4.2 The camera control panel on the left side of the video window

Camera control panel is used to control the camera to obtain the best video according to the specific situation When touching the left side of the video window, it will pop up automatically

Camera Control Panel	Function	Function Description
	<b>Snap</b>	Capture image and save it to the SD card or USB flash drive
	<b>Record</b>	Record video and save it to the SD card or USB flash drive
	<b>Video Freeze</b>	Make preview Video Freeze
	<b>Browse</b>	Browse images and videos in the SD Card or USB flash drive
	<b>Compare</b>	Compare image with the current video
	<b>Zoom In</b>	Zoom In the Video Window
	<b>Zoom Out</b>	Zoom Out the Video Window
	<b>Settings</b>	Comprehensive Settings
	<b>About</b>	Check the version of Embedded touch/mouse driven software
	<b>Measurement</b>	Measuring objects
	<b>Image Adjustment</b>	Adjust the image effect

## 4.3 The measurement toolbar on the top of the video window

When touching the button -  - on the bottom-left of the **camera control panel**, the **measurement toolbar** will be displayed. The commands are explained as follows:

Icon	Function
	Execute calibration to determine the corresponding relation between magnification and resolution, which will establish the corresponding relationship between measurement unit and the sensor pixel size. Calibration needs to be done with the help of a micrometer. For detailed steps of carrying out calibration, please refer to ImageFocus Alpha manual
	Export the measurement information to CSV file(*.csv)
	Delete all the measurement objects from the video window
	Angle
	4 Points Angle
	Point

	Arbitrary Line
	3 Points Line
	Horizontal Line
	Vertical Line
	Parallel
	3 Points Vertical Line
	Rectangle
	3 Points Parallel
	Ellipse
	5 Points Ellipse
	Circle

	3 Points Circle
	Annulus
	3 Points Annulus
	Two Circles and Its Center Distance
	3 Points Two Circles and Its Center Distance
	Arc
	Text
	Polygon
	Curve
	Scale Bar
	Arrow

	<p>When the measurement ends, left-click on a single measurement object and the <b>object location &amp; properties control</b> Bar will show up. User could move the object by dragging the object with hand or mouse. But more accurate movement could be done with the buttons. The icons on the control bar mean <b>Move Up, Move Down, Move Left, Move Right, Color Adjustment</b> and <b>Delete</b></p>
--	---

#### 4.4 The image adjustment toolbar at the bottom of the video window

When the - button on the bottom-left of the camera control panel, the **image adjustment toolbar** will be displayed - -. The commands are explained as follows:

Icon	Function	Icon	Function
	Exposure and gain		White balance
	Color adjustment		Sharpness and denoise
	Flip		Light source frequency (Anti flicker)

The following describes the above functions in detail:

##### 4.4.1 Exposure and Gain

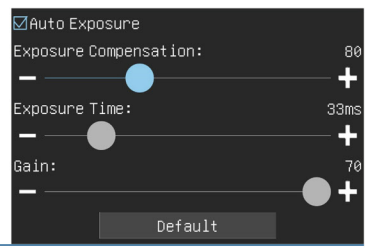

After touching -  -, the Exposure and gain dialog box will be displayed

Auto exposure	When Auto exposure is checked, the system will automatically adjust exposure time and gain according to the value of exposure compensation
Exposure compensation	Available when Auto exposure is checked. Slide to left or right to adjust Exposure compensation according to the current video brightness to achieve proper brightness value
Exposure time	Available when Auto exposure is unchecked. Slide to left or right to reduce or increase exposure time, adjusting brightness of the video
Gain	Adjust Gain to reduce or increase brightness of video. The noise will be reduced or increased accordingly
Default	Restore the Exposure time and Gain settings to the default values when the camera leaves the factory

#### 4.4.2 White balance

After touching -  -, the White balance dialog box will be displayed

Auto	White balance adjustment according to the window video every time the button is clicked
Manual	Adjust the red, green or blue item to set the video White balance
ROI	Check the ROI item will display a red ROI rectangle on the video window, drag it to the interested area will perform the White Balance according to the area video data
Red	Slide to left or right to decrease or increase the proportion of red in RGB on video
Green	Slide to left or right to decrease or increase the proportion of green in RGB on video
Blue	Slide to left or right to decrease or increase the proportion of blue in RGB on the video
Default	Restore the White balance setting to the default value when the camera leaves the factory

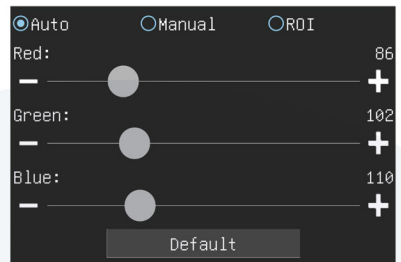

#### 4.4.3 Color adjustment

After touching -  -, the Color adjustment dialog box will be displayed

Saturation	Adjust Saturation level of the video
Gamma	Adjust Gamma level of the video. Slide to the right side to increase gamma and to the left to decrease gamma
Contrast	Adjust Contrast level of the video. Slide to the right side to increase contrast and to the left to decrease contrast
Brightness	Adjust Brightness level of the video. Slide to the right side to increase brightness and to the left to decrease brightness
Default	Restore the settings of Color adjustment to the Default values when the camera leaves the factory



#### 4.4.4 Sharpness and Denoise

After touching -  -, the Sharpness and Noise reduction dialog box will be displayed

Sharpness	Adjust Sharpness level of the video
Denoise	Slide left or right to Denoise the video
Default	Restore the Sharpness and Denoise settings to the default values when the camera leaves the factory



#### 4.4.5 Flip

After touching -  -, the Flip dialog box will be displayed

Horizontal	After opening, it will flip in horizontal mode
Vertical	After opening, it will flip vertical mode



#### 4.4.6 Light Source Frequency

After touching -  -, the Light source frequency dialog box will be displayed

AC(50HZ)	Check AC(50HZ) to eliminate flickering caused by 50Hz illumination
AC(60HZ)	Check AC(60HZ) to eliminate flickering caused by 60Hz illumination
DC	For DC illumination, there will be no fluctuation in light source so no need for compensating light flickering



### 4.5 Setting

In the Camera control panel, the setting function is relatively complex, and the details are as follows:

#### 4.5.1 Setting>Magnification

Figure below left: *Comprehensive magnification calibration settings page*

Name	The name of the magnification, usually the magnification of the objective of the microscope is used as the magnification name when calibration, such as 4X, 10X, 40X,100X, etc. Besides, other user-defined information could be added into the magnification name too, for example, microscope model, operator name, etc.
Resolution	Pixels per meter. Image device like microscopes have high resolution value
Clear All	Click the Clear all button will clear the calibrated magnification
Delete	Click Delete to delete the selected magnification
Up	Click Move up to move up the selected magnification
Down	Click Move down to move the selected magnification down

#### 4.5.2 Settings>Image format

Figure below right: *Comprehensive image format settings page*

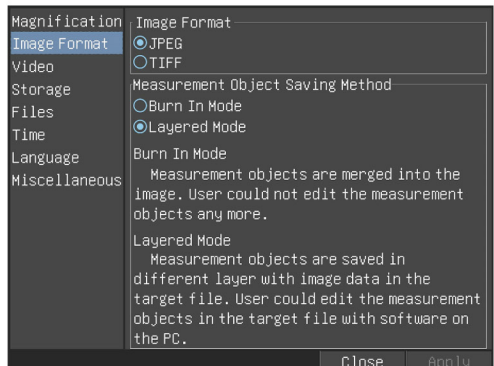
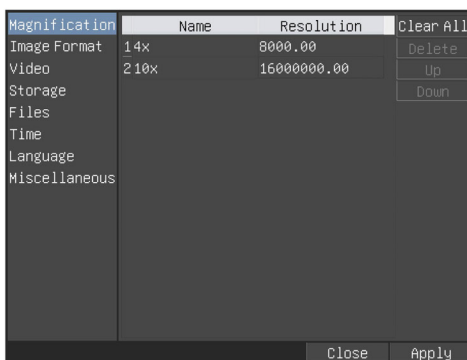

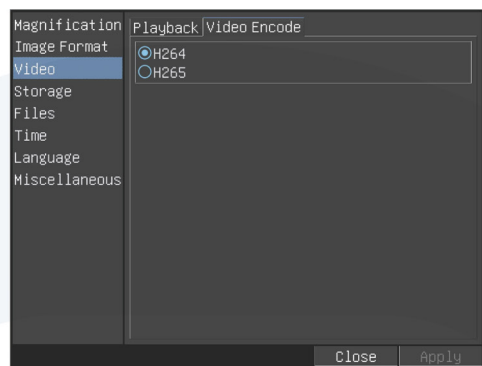
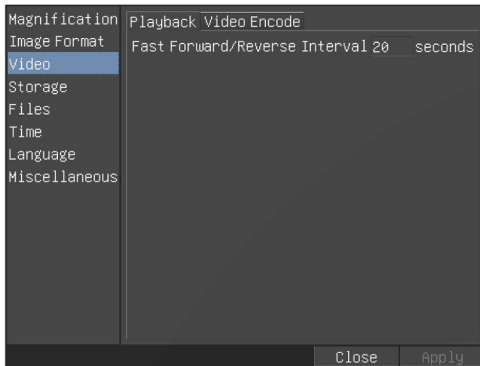

Image format	<p><b>JPEG:</b> The extension of JPEG file can get very high compression rate and display very rich and vivid images by removing redundant images and color data. In other words, it can get better image quality with the least disk space. If Measurement Objects are available, the Measurement Objects will be burned into the image and the Measurement Objects cannot be edited.</p> <p><b>TIFF:</b> Tag Image File Format(TIFF) is a flexible bitmap format that is mainly used to store images including photos and artistic images.</p>
Measurement Object Saving Method	<p><b>Burn in Mode:</b> The Measurement objects are merged into the current image. User could not edit the Measurement objects anymore. This mode is not reversible</p> <p><b>Layered Mode:</b> The Measurement objects are saved in different layer with current image data in the target file. User could edit the Measurement objects in the target file with some software on the PC. This mode is reversible</p>

#### 4.5.3 Settings>Video

Figure left: Comprehensive setting of video settings page-playback

Figure right: Comprehensive setting of video settings page-video encode



Playback	Fast forward/reverse interval: The time interval of the playback of video files
Video encode	You can choose H264 or H265 encoding. H265 encoding can significantly reduce encoding bandwidth and save storage space under the same encoding quality

#### 4.5.4 Setting>Storage

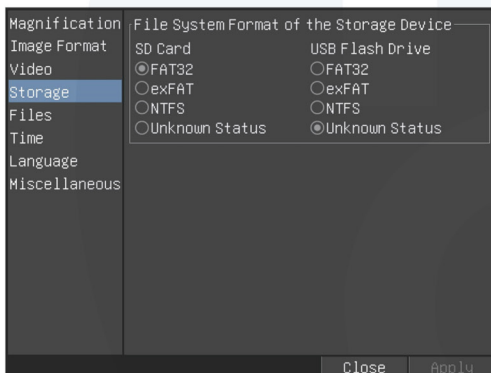

File system format of the storage device	<p>List the file system format of the current storage device</p> <p><b>FAT32:</b> The file system of SD card is FAT32. The maximum video file size of single file in FAT32 file system is 4G bytes</p> <p><b>exFAT:</b> The file system of SD card is exFAT. The maximum video file size of single file in FAT32 file system is 16E bytes</p> <p><b>NTFS:</b> The file system of SD card is NTFS. The maximum video file size of single file is 2T bytes.</p> <p><b>Unknown status:</b> SD card not detected or the file system is not identified</p>
--	---

Note: When the SD card and USB flash disk exist at the same time, the SD card is preferred. If a USB flash disk is used for storage, a 3.0 USB flash disk is recommended

#### 4.5.5 Setting>Files

Image file name	<p><b>Auto:</b> The image files will be saved automatically with the specified prefix.</p> <p><b>Manual:</b> Users has to specify the file name before image saving.</p>
Video file name	<p><b>Auto:</b> The video file will be saved automatically with the specified prefix.</p> <p><b>Manual:</b> Users has to specify the Video File Name before video recording.</p>

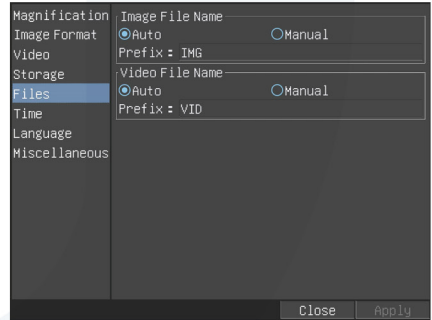

#### 4.5.6 Setting>Time

Time	User can set Year, Month, Day, Hour, Minute and Second here
------	---

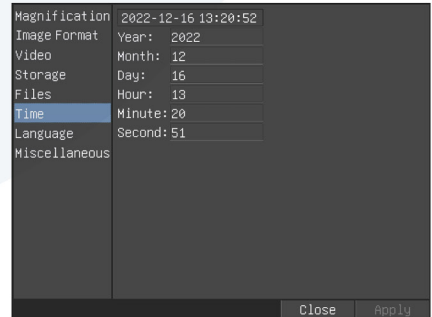

#### 4.5.7. Setting>Language

English	Set language of the whole software into English
Simplified Chinese	Set language of the whole software into Simplified Chinese
Traditional Chinese	Set language of the whole software into Traditional Chinese
Korean	Set language of the whole software into Korean
Thailand	Set language of the whole software into Thai
French	Set language of the whole software into French
German	Set language of the whole software into German
Japanese	Set language of the whole software into Japanese
Italian	Set language of the whole software into Italian
Russian	Set language of the whole software into Russian

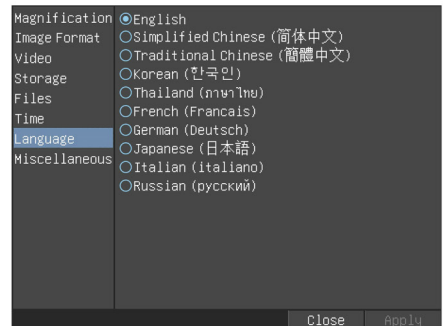

#### 4.5.8 Comprehensive Miscellaneous Settings Page

ROI color	Choosing the ROI rectangle line color
Mode	Mouse mode or touch mode can be selected
Auto exposure	The maximum exposure time during auto exposure process could be specified. Setting this item to a lower value could guarantee a faster frame rate during Auto Exposure
Camera parameters: import	Import the camera parameters from the SD card to use the previously exported Camera Parameters
Camera parameters: export	Export the camera parameters to the SD card to use the previously exported Camera Parameters
Reset to factory defaults	Restore camera parameters to its factory status

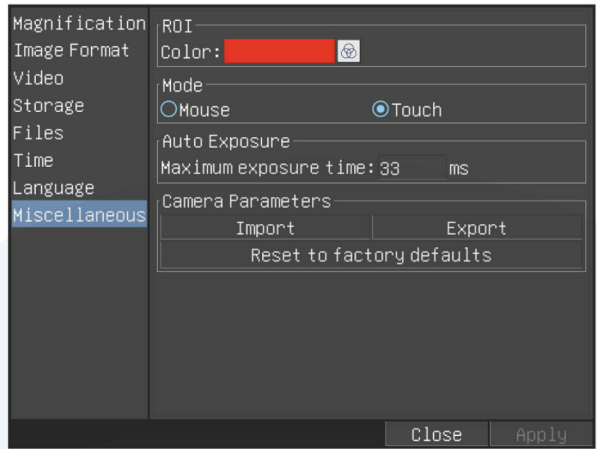

## 5. Sample photos

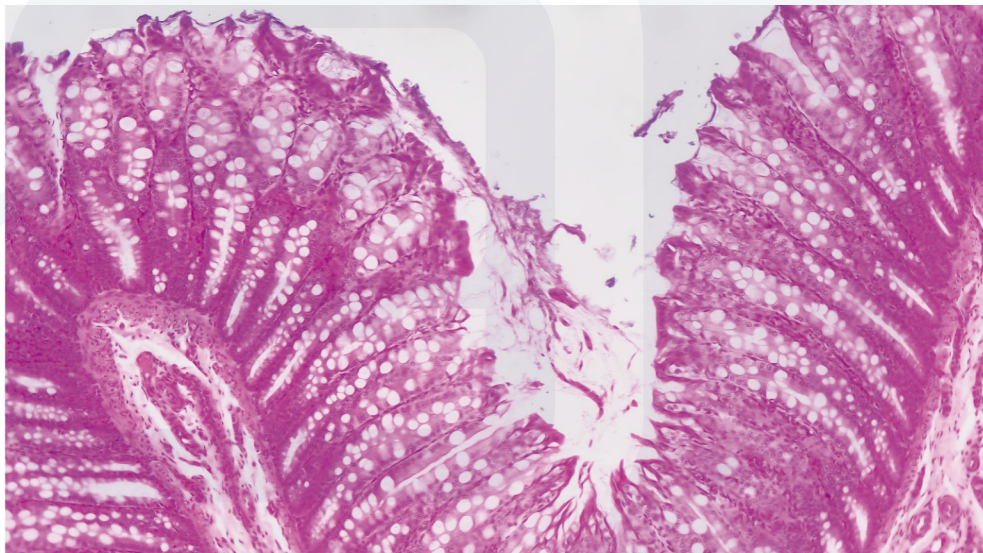

*Large Intestine*

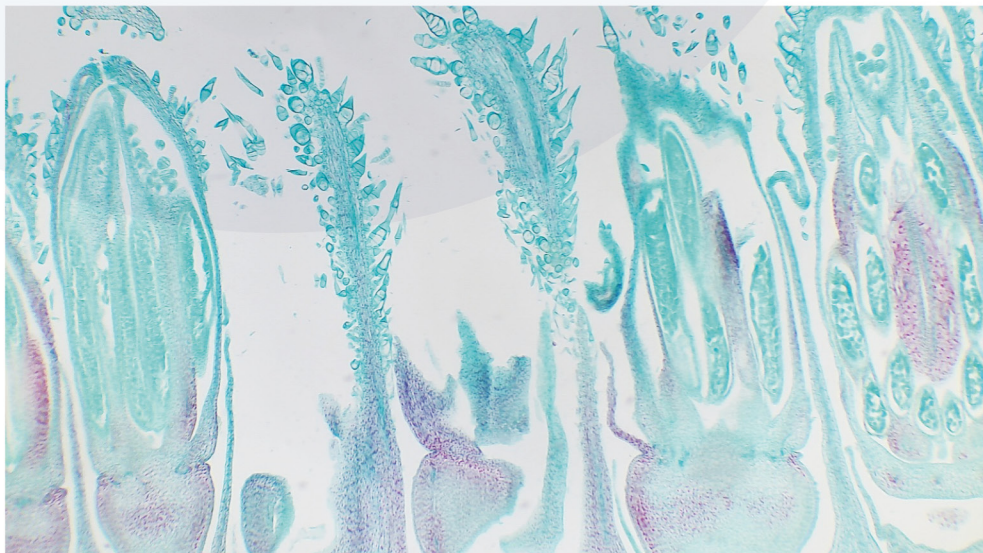

*Sunflower Flower*