

Achios-X

observer



1. Introduction

Thank you for purchasing the Euromex Achios-X Observer

The Achios-X Observer series has been designed with all kind of Life Sciences applications and great durability in mind. This resulted in a modern, robust and high level microscope for advanced use, equipped with the best optical and mechanical components. An ideal microscope for daily cytology and anatomic pathology use. The 25 mm field of view of the eyepieces and the plan apochromatic objectives enable observations with perfect color rendering at high resolving powers. Specific attention to production methods resulted also in an excellent price/performance ratio. Please read this manual carefully before using this product to ensure correct and save usage

- The contents of this manual are subject to change without notice
- The appearance of the actual product can differ from the models described in this manual
- Not all equipment mentioned in this manual has to be part of the set you have purchased
- All optics are anti-fungus treated and anti-reflection coated for maximum light throughput

Contents

2. General safety instructions	3
2.1 Dangers associated with the operation	3
2.2 Photobiological safety LED, important safety instructions	3
2.3 Prevention of biological and infectious hazards	3
2.4 Disinfection and decontamination:	4
2.5 Environment, storage and use	5
3. Configuration, construction and controls	6
4.1 Installation of mechanical stage	9
4.2 Installation of the head	9
4.3 Installation of photo tube	10
4.4 Installation of the eyepieces	10
4.5 Installation of the condenser	10
4.6 Installation of objectives	11
5. Operation	12
5.1 Turning on the power	12
5.2 LCD screen function setting and adjustment	12
5.3 Placing the slide	14
5.4 Getting the specimen in focus	14
5.5 Adjusting the coarse focus tension	14
5.6 Setting the focus lock	14
5.7 Switching the fine focus knobs	15
5.8 Adjust interpupillary distance	15
5.9 Adjust diopter of the eyepieces	15
5.10 The correct eye point	16
5.11 Centering the condenser	16
5.12 Using the aperture diaphragm	16
6. Cleaning optics	17
7. Troubleshooting	18

2. General safety instructions

Intended use: a non-medical device

This microscope is intended for general observation of cells and tissues, with transmitted/reflected illumination and with the specimen fixed on a slide

Intended use: medical device class I

This microscope is intended for observation and diagnostics of cells and tissues at hospitals or by physicians and veterinaries in private practice in pathology, anatomy and cytology applications. To be used with transmitted/reflected illumination and with the specimen fixed on a slide. Physicians and veterinaries use microscopes to identify the different types of cells and spot abnormal cells. This product helps in identifying and treating diseases

2.1 Dangers associated with the operation

- Improper use could result in injury, malfunction or damage to property. It must be ensured that the operator informs every user of existing hazards
- Danger of electrocution. Disconnect the power to the entire lighting system before installing, adding or changing any component
- Not to be used in corrosive or explosive environments
- Avoid direct exposure of eyes to the collimated light beam or direct light from the light guides or fibres
- To avoid a hazard to children, account for all parts and keep all packing materials in a safe place

2.2 Photobiological safety LED, important safety instructions

- Avoid direct eye exposure to any LED light source while switched on
- Before looking through the eyepieces of the microscope, lower the intensity of the LED illumination
- Avoid long and high-intensity exposure to LED light because this may cause acute damage to the retina of the eye

2.3 Prevention of biological and infectious hazards

Infectious, bacterial or viral biohazard substances under observation may be a risk to the health of humans and other living organisms. Special precautions should be taken during in vitro medical procedures:

- **Biological hazards:** keep a logbook of all the biological substances or pathogenic microorganisms that were under observation with the microscope and show it to everybody before they use the microscope or before they do some maintenance work on the microscope! Agents can be bacterial, spores, enveloped or non-enveloped virus particles, fungi or protozoa
- **Contamination hazard:**
 - A sample that is properly enclosed with a cover glass never comes in direct contact with the microscope parts. In that case prevention of contamination lies in the handling of the slides; as long as the slides are decontaminated before use and are undamaged and treated normally, there is virtually zero risk of contamination
 - A sample that is mounted on a slide without cover glass, can come in contact with components of the microscope and may be a hazard to humans and/or the environment. Therefore, check the microscope and accessories on possible contaminations. Clean the microscope surfaces and its components as thoroughly as possible. Should you identify a possible contamination, inform the local responsible person in your organisation
 - Microscope operators could be contaminated from other activities and cross-contaminate components of the microscope. Therefore, check the microscope and accessories on possible contaminations. Clean the microscope surfaces and its components as thoroughly as possible. Should you identify a possible contamination, inform the local responsible person in your organisation. it is recommended to wear sterile gloves when preparing the slides and handling the microscope in order to reduce contamination by the operator
- **Infection hazard:** direct contact with the focusing knobs, stage adjustments, stage and eyepieces/tubes of the microscope can be a potential source of bacterial and/or viral infections. The risk can be limited by using personal eyeshades or eyepieces. You can also use personal protections such as operation gloves and/or safety goggles, which should be changed frequently to minimize the risk

- **Disinfectant hazards:** before cleaning or disinfecting, check if the room is adequately ventilated. If not, wear respiratory protective gear. Exposure to chemicals and aerosols can harm human eyes, skin and respiratory system. Do not inhale vapours. During disinfection, do not eat, drink or smoke. Used disinfectants must be disposed of according to local or national regulations for health and safety

2.4 Disinfection and decontamination:

- Exterior casing and mechanical surfaces must be wiped with a clean cloth, dampened with a disinfectant
- Soft plastic parts and rubber surfaces can be cleaned by gently wiping a clean cloth, dampened with a disinfectant. Discoloration can occur if alcohol is used
- The front lens of eyepieces and objectives are sensitive to chemicals. We recommend not to use aggressive disinfectants but to use lens paper or a soft fibre-free tissue, dampened in cleaning solution. Cotton swabs may also be used. We recommend you use personal eyepieces without eyeshades in order to minimize risk
- Never immerse or dip the eyepiece or objective into a disinfectant liquid! This will damage the component
- Never use abrasive compounds or cleaners that may damage and scratch optical coatings
- Properly clean and disinfect all possible contaminated surfaces of the microscope or contaminated accessories before storing for future use. Disinfection procedures must be effective and appropriate
- Leave the disinfectant on the surface for the required exposure time, as specified by the manufacturer. If the disinfectant evaporates before the full exposure time, reapply disinfectant on the surface
- For disinfection against bacteria, use a 70% aqueous solution of isopropanol (isopropyl alcohol) and apply for at least 30 seconds. Against viruses, we recommend to refer to specific alcohol or non-alcohol based disinfection products for laboratories

Before returning a microscope for repair or maintenance through a Euromex dealer, an RMA (return authorization form) together with a decontamination statement must be filled in! This document - available from Euromex for any reseller- must be shipped together with the microscope at all times

Reference documents:

World Health Organisation:

<https://www.who.int/ihr/publications/biosafety-video-series/en/>

Robert Koch Institut:

<https://link.springer.com/content/pdf/10.1007/s00103-013-1863-6.pdf>

US Centre for Disease Control and prevention

<https://www.cdc.gov/infectioncontrol/guidelines/disinfection/index.html>

Handle with care

- This product is a high quality optical instrument. Delicate handling is required
- Avoid subjecting it to sudden shocks and impacts
- Impacts, even small ones, can affect the precision of the instrument

Handling the LED

Note: Always disconnect the power cord from your microscope before handling the LED bulb and power unit and allow the system to cool down approximately 35 minutes to avoid burns

- Never touch the LED with your bare hands
- Dirt or fingerprints will reduce the life span and can result in uneven illumination, lowering the optical performance
- Use only original Euromex replacement LEDs
- The use of other products may cause malfunctions and will void warranty
- During use of the microscope the power unit will get hot; never touch it while in operation and allow the system to cool down approximately 35 minutes to avoid burns

Dirt on the lenses

- Dirt on or inside the optical components, such as eyepieces, lenses, etc., affects the image quality of your system negatively

- Always try to prevent your microscope from getting dirty by using the dust cover, prevent leaving fingerprints on the lenses and clean the outer surface of the lens regularly
- Cleaning optical components is a delicate matter. Please, read the cleaning instructions further on in this manual

2.5 Environment, storage and use

- This product is a precision instrument and it should be used in a proper environment for optimal use
- Install your product indoors on a stable, vibration free and level surface in order to prevent this instrument to fall thereby harming the operator
- Do not place the product in direct sunlight
- The ambient temperature should be between 5 to +40°C and humidity should be within 80% and 50%
- Although the system is anti-mold treated, installing this product in a hot, humid location may still result in the formation of mold or condensation on lenses, impairing performance or causing malfunctions
- Never turn the right and left focus knobs in opposite directions at the same time or turn the coarse focus knob past its farthest point as this will damage this product
- Never use undue force when turning the knobs
- Make sure that the microscope system can dissipate its heat (fire hazard)
- Keep the microscope away from walls and obstructions for at least approximately 15 cm
- Never turn the microscope on when the dust cover is in place or when items are placed on the microscope
- Keep flammable fluids, fabric, etc. well out of the way

Disconnect power

Always disconnect your microscope from power before doing any maintenance, cleaning, assembling or replacing LEDs to prevent electric shocks

Prevent contact with water and other fluids

Never allow water or other fluids to come in contact with your microscope, this can cause short circuiting your device, causing malfunction and damage to your system

Moving and assembling

- This microscope is a relatively heavy system, consider this when moving and installing the system
- Always lift the microscope by holding the main body and base of the microscope
- Never lift or move the microscope by its focusing knobs, stage or head
- When needed, move the microscope with two persons instead of one

3. Configuration, construction and controls

This chapter describes the main parts and functions of the Achios-X Observer

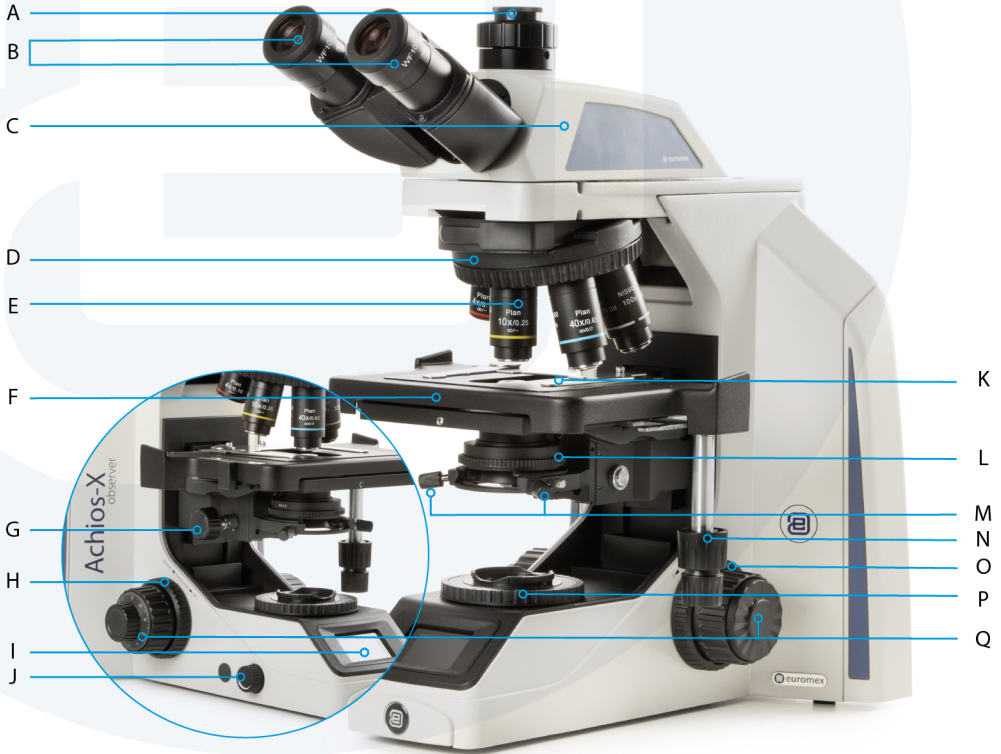

A	Photo port
B	Eyepieces
C	Trinocular head
D	Nosepiece
E	Objectives
F	X-Y Stage

G	Condenser focussing knob
H	Focusing lock dial
I	SLC display
J	SLC display dial/switch
K	Double slide holder
L	Condenser



M	Condenser centering screws
N	Coaxial control X-Y stage movement
O	Tension control dial
P	Köhler illumination
Q	Coarse and fine focusing control knobs
R	Power input

S	Transportation handle
T	Allen wrench tool
U	Power unit
V	Excess cable storage
W	On/off switch (not visible)

4. Assembling Achios-X Observer

This chapter describes the steps that need to be taken to assemble the Achios-X Observer microscope. Euromex Microscopes will always try to keep the number of assembly steps for their customers as low as possible but there are some steps that need to be taken. The steps mentioned on the following pages are not always necessary but described for your convenience nonetheless. The diagram shows the order of each component's installation

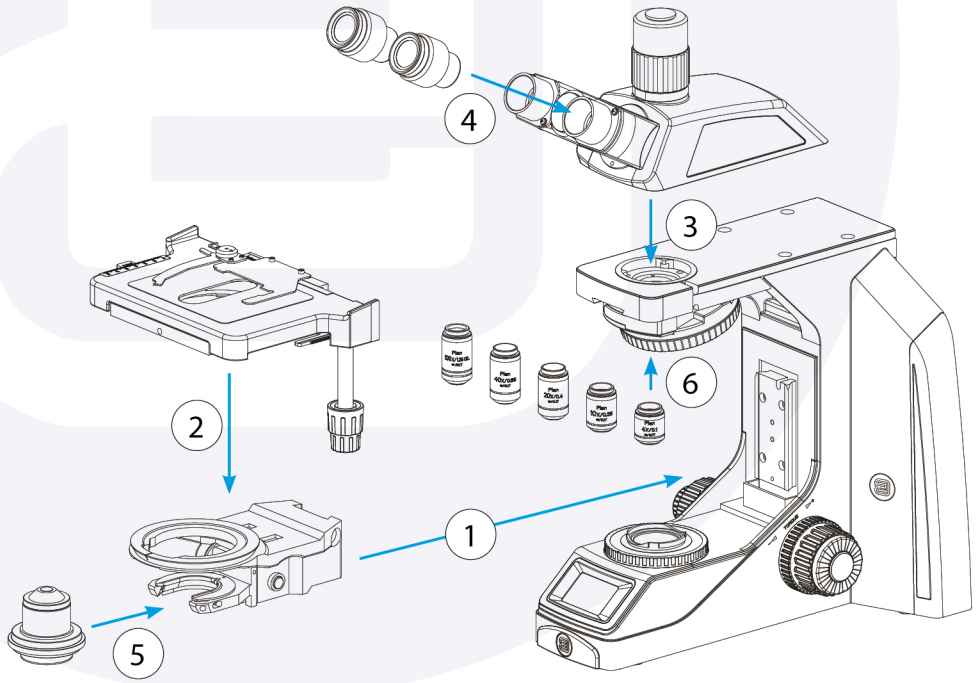

Step 1	Attaching the focus cassette (factory installed)	Step 4	Placing the eyepieces
Step 2	Attaching the mechanical X/Y stage	Step 5	Placing the condenser (factory installed)
Step 3	Placing the microscope head, C-mounts and photo ports	Step 6	Mounting the objectives

4.1 Installation of mechanical stage

- Turn the stage platform and the condenser all the way down (1 and 2)
- Turn the revolver so that the objectives are out of the way (3)
- Roughly align the stage by moving it towards you until the stage touches the rim of the platform (4.1, 4.2), then move it down (4.3)
- secure the stage with the Allen tool (5)



4.1.1



4.1.2



4.1.3



4.1.4.1



4.1.4.2



4.1.4.3



4.1.5

4.2 Installation of the head

- Remove the dustcaps from the microscope and the head (1 and 2)
- Install the head into the microscope circular swallow tail (3)
- Tighten the screws with the Allen tool to secure the head (4)



Note: In the process of installing the head, pay attention to one hand always holding the head to prevent falling



4.2.1



4.2.2



4.2.3



4.2.4

4.3 Installation of photo tube

- Remove dustcap from the head (1)
- Put the photo tube into the head (2)
- Tighten the screw with the Allen tool to secure the photo tube (3)
- By turning the photo tube (when a camera is installed) the parfocality can be adjusted



4.3.1



4.3.2



4.3.3



4.3.4

4.4 Installation of the eyepieces

- Unlock the dustcover, if necessary, with a small Allen tool (1)
- Remove dust covers from the eyepiece tubes (2)
- Insert the eyepieces into the eyepiece tubes (3)
- Lock the eyepieces at will, with the Allen screw shown in 1



4.4.1



4.4.2



4.4.3

4.5 Installation of the condenser

(Note: condenser is already installed so we show you how to take it out in order to replace it)

- Unscrew the screw on the side (1)
- Slide the condenser towards you to take it out (2)
- How to center the condenser, view paragraph 5.11



4.5.1



4.5.2

4.6 Installation of objectives

(Fig. 5. Note: objectives are already installed. We show you how to change the installation)

4.6.1 Changing the objectives

- Lower the mechanical stage as far as it goes
- After turning on the microscope, (see paragraph 5.1) the position of the revolver - the objective that is placed in the light path - will be shown on the LCD screen (1)
- Even if no objective is installed, the display will still show the objective that is preinstalled in that place (2)
- In case you would like to install f.i. a 60x objective you need to move the 100x objective to a vacant hole in order to insert the 60x in the hole of the 100x objective (1, 2 and 3)



4.6.1



4.6.2

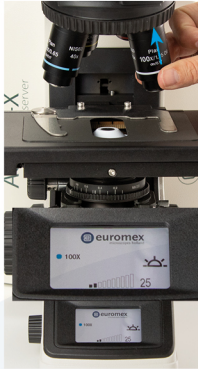

4.6.3



4.6.4

4.6.2 Adjusting the display accordingly

- Changing of the settings is done with the dial/switch on the side of the body (4), which is either turned, pushed or pushed and held
- Press the dial/switch, until menu is shown (1). Turn it to select "Set" and press again (2)
- Turn dial/switch to select 100x (3) and press (4)
- Turn the dial/switch to select "60" (5) and press (6)
- Repeat this process for the new position of the 100x objective (7, 8, 9)
- Turn the dial/switch to select "Save" (10)
- Turn dial/switch to "Exit" to exit "Set"

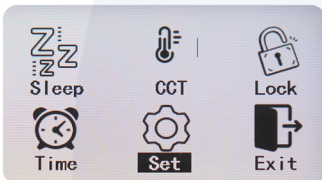

4.6.2.1



4.6.2.2

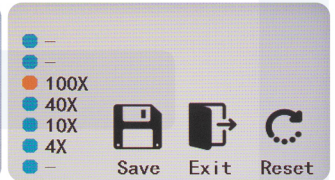

4.6.2.3

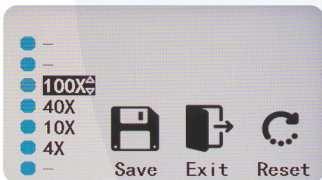

4.6.2.4

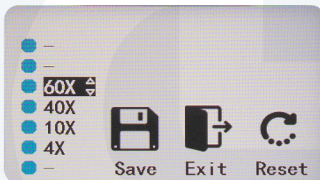

4.6.2.5

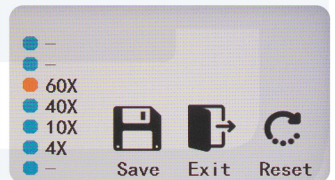

4.6.2.6

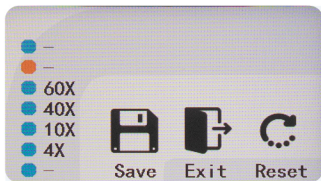

4.6.2.7

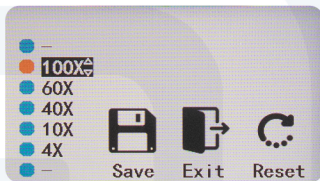

4.6.2.8

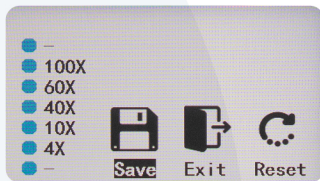

4.6.2.9

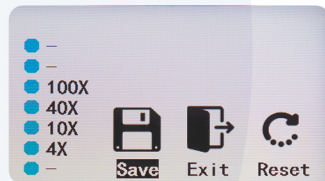

4.6.2.10

5. Operation

5.1 Turning on the power

- Put the adapter in the holder on the back (1)
- Connect the adapter to the power supply (2) and insert the adapter plug into the back of the microscope (3)



Note: The Achios-X Observer microscopes support a wide range of operating voltages: 100 to 240 V.

Please use a grounded power connection

- Press the main switch on the back of the microscope to "I" (4)



5.1.1



5.1.2



5.1.3



5.1.4

5.2 LCD screen function setting and adjustment

- Press and hold the dial/switch for 3 seconds to enter the function setting interface (1)
- Switch functions by turning the dial/switch up or down, and click to select the function

5.2.1 Sleep:

- Select "Sleep" by rotating the dial/switch, click to enter the sleep state (1), and "SLEEP" will be displayed
- Click the dial/switch again to release the sleep state, and the "SLEEP" on the display disappears, showing normal working mode

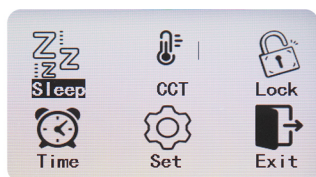

5.2.1

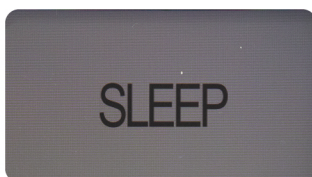

5.2.2

5.2.2 Color temperature/brightness adjustment switch:

- Select **CCT** using the dial/switch (3), click to enter the color temperature adjustment state (4)
- Turn the dial/switch, the color temperature decreases, and vice versa. The color temperature adjustment ranges from 3000K to 7000K
- To exit the CCT menu, hold the dial/switch. Display shows "On Down" (5)
- Click the dial/switch to enter the brightness adjustment state (6), the general working state). When turning the dial/switch, the brightness increases, and vice versa (6)

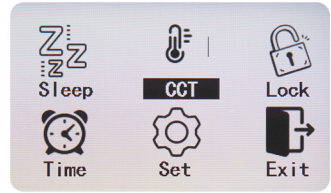

5.2.3



5.2.4

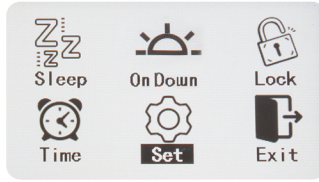

5.2.5



5.2.6

5.2.3 Light intensity lock:

- Select "Lock" in the menu, click to enter the lock state (7). When locked, the dial/switch no longer functions, and the LCD screen displays "LOCK" (8). In this case, when turning to another objective, the brightness automatically changes to the corresponding objective's brightness, but the dial/switch is still inoperative
- Press and hold the dial/switch for 3 seconds to enter the function setting interface. Rotate it to select the Lock function and click to release the lock function. "LOCK" on the screen disappears

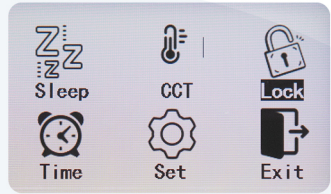

5.2.7



5.2.8

5.2.4 Automatic shut down

- Select "Time" in the menu, click to enter the time setting state (9). Turning the dial/switch can achieve an increase or decrease in time, with a score grid value of 5 minutes. Up to 8 hours can be set
- After setting the desired time; the setting is successful when the time number jumps three times, then stops jumping. Time begins to decrease after one minute

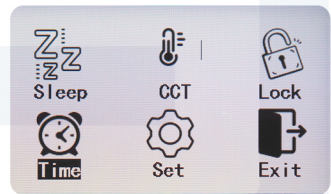

5.2.9



5.2.10

5.3 Placing the slide

- Lower the condenser slightly from the uppermost position by turning the condenser focus knob
- Open both condenser and field diaphragm entirely
- Bring the 4x objective (or lowest objective in your configuration) into the optical path by rotating the nosepiece until the right objective clicks into position
- Put the slide on the stage and gently push it away from you between the slide holders all the way to the back
- When required you can put a second slide on the stage
- Use the X and Y axis control knobs of the mechanical stage to move to area of interest of the slide into the light path



5.4 Getting the specimen in focus

- Position the specimen in the center of the light path by using the X-Y adjustment handles (1)
- Use the coarse control knobs (2) to adjust the focus quickly and roughly
- Get the specimen into sight while looking through the eyepieces
- Then use the fine focus control knob (3) to adjust the focus in detail

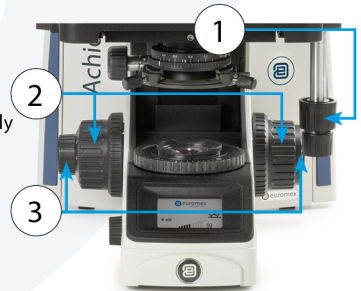

5.5 Adjusting the coarse focus tension

Next to the right side coarse focus knob there is a ring for adjusting the coarse focus tensions. This can be used to make the coarse control move lighter or heavier, according to your preference, or when the stage lowers by itself



5.6 Setting the focus lock

Next to the left side coarse focus knob there is a ring setting the focus lock. The focus lock can be used to limit the maximum position of the stage at a certain height. This is ideal for preventing objectives to get damaged, slides from breaking or to set the stage at a reference height

- Move the stage to the desired height then fix the ring tight to lock the mechanical stage's maximum height
- The stage still can be lowered but the highest position is now limited to the set position
- Release the ring to undo the focus lock



5.7 Switching the fine focus knobs

The fine focus knobs can be switched from left to right to meet your preference

- Pull the knobs with moderate force to release the magnet which is holding the knobs onto the stand
- Attach the magnets onto the holder and let it grab the knobs again to mount them onto the holder

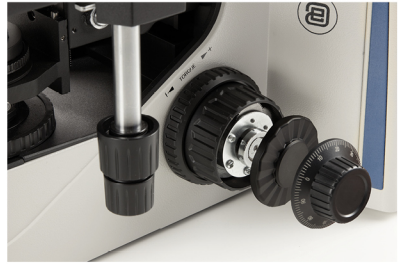

5.8 Adjust interpupillary distance

The Achios-X Observer has an interpupillary distance range of 47 to 78 mm. The correct interpupillary distance is reached when one round image is seen in the field of view

This distance can be set by either pulling the tubes towards each other or pulling them from each other. This distance is different for each observer and this should be set individually. When more users are working with the microscope it is recommended to remember your interpupillary distance for a quick setup during new microscopy sessions



Field of view before adjustment

Field of view after adjustment



5.9 Adjust diopter of the eyepieces

In order to compensate for human eye differences, distortion, thickness differences in cover glasses and tune for the best parfocality between objectives, you can use the diopter to do so. Take a good prepared slide for your reference:

- Set (both) the diopter adjustments of the eyepieces to "0"
- Select the 10x objective, look for a interesting area on the specimen and focus on this area
- Select the 40x objective and focus on the specimen

Warning: don't change the coarse and fine adjustment anymore

- With your dominant eye open (close your other eye), rotate the diopter adjustment from "+" to "-" until the selected area get as sharp as possible
- If during this operation the image becomes unsharp, take your eyes from the eyepieces and turn the diopter adjustment, without looking into the eyepieces, a few divisions back from "-" to "+" .
- Look into the eyepiece again and turn the diopter adjustment from '+' to '-' until the selected area on your specimen gets the optimal sharpness
- Repeat for your non-dominant eye, and with the second diopter



Verification:

- Take your eyes from the eyepieces and look for 2 seconds to a far point in the room in order to "reset" your eyes
- Look again into the eyepieces. If the adjustment is not good, repeat the operation till you reach the same sharpness for the 10x and 40x objective without touching the coarse and micrometric adjustments

5.10 The correct eye point

The eye point is the distance from the eyepiece to your pupil. To obtain the correct eye point, move the eyes towards the eyepieces until a sharp image is reached at a full field of view



5.11 Centering the condenser

- Move the condenser to the top position (1)
- Open the condenser diaphragm (2)
- Focus on a specimen using the smallest objective (f.e. 4x or 10x objective)
- Close the field diaphragm (3)
- Use screws (4) to move the condenser diaphragm into the view center
- Open the field diaphragm carefully to the outside of the field of view, to ensure the condenser diaphragm is in the center. The condenser has been centered properly

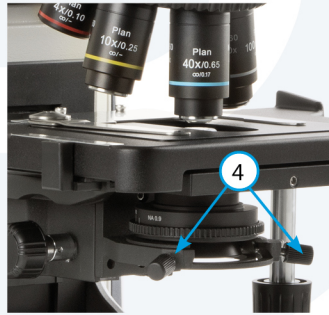

5.12 Using the aperture diaphragm

The condenser diaphragm should be used to adjust the numerical aperture (resolving power) and image contrast. Not to adjust image brightness

6. Cleaning optics

How to keep the optics clean?

Dust and dirt particles have a negative affect on the image quality. Keeping the optical system of your microscope clean is essential for the best image quality and overall lifetime of your microscope. Dust and dirt on optical elements such as lenses, prisms and filters that are left unattended can become difficult - or even impossible - to remove and may cause mold

FIGURE A |

- Place your objective or eyepiece on a secure location
- Objectives can be screwed into the cover of an objective case
- Eyepieces can be placed in the microscope box
- Condensers and collector lenses can remain in place in the microscope

FIGURE B |

- To prevent scratches on coatings and optical glass try to remove dirt and dust that sticks to the optical surface first with an air-blower or with pressurized dry air (oil-free and under moderate pressure version only)

FIGURE C |

- Use an absorbent lens paper or cotton swap.
- Dampen a swap or towel with a small amount of lens cleaning fluid or cleaning mixture (either pure iso-propanol or a mixture of 7 parts ether and 3 parts alcohol)

FIGURE D |

- Clean the lens by using the tip of the cotton swap or the lens paper. Use enough lens paper so that solvents do not dissolve oils from your hands which can make their way through the paper on to the coated surface
- When cleaning a large lens surface, wipe with little pressure from the centre towards the periphery in a circular motion. **Do not use zig-zag motion**
- Discard each lens paper or cotton swap after a single use

FIGURE E |

- Wait until the cleaning fluid is evaporated, or speed up this process by using pressurized dry air
- Check if the surface is clean by using a magnifying glass
- Place the cleaned item back on the microscope

Please note that cleaning of the optical surfaces indicated in this instruction only applies to external surfaces of objectives, eyepieces, filters and condensers. Internal surfaces must always be done by your Euromex microscopes distributor

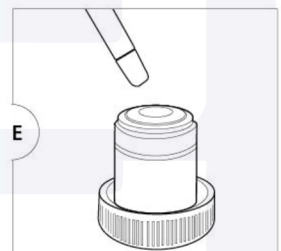
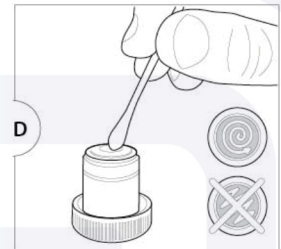
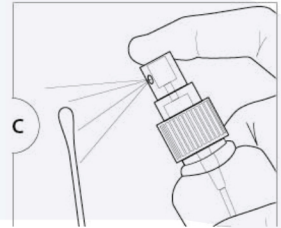
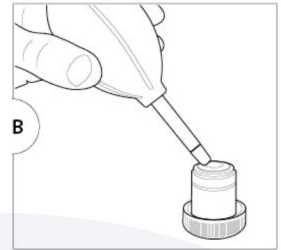
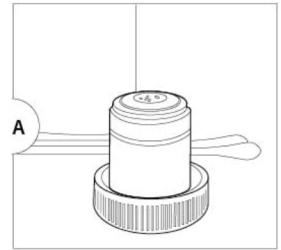

7. Troubleshooting

Proper use and maintenance ensure best performance of your Achios-X Observer. If problems occur this chapter explains how to resolve most issues. Please make sure this chapter is read and checked before contacting your Euromex distributor for service. If a problem is not described in this list or the suggested solution does not bring the result needed, please contact your Euromex distributor

Problem	Cause	Action
There is no light from the lamp	No power	<i>Check if the power cable is connected well, try other power cable</i>
	The bulb is not inserted	<i>Remove the bulb and place it back</i>
	The bulb is defective	<i>Remove the bulb and place it back</i>
	There is no power from the mains connection	<i>Replace it</i>
OPTICAL SYSTEM		
Problem	Cause	Action
The edge of the field of view is dark or the brightness is not uniform	The nosepiece is not in the located position (objective and light path are not coaxial)	<i>Locate the nosepiece properly where it clicks</i>
	The image of the lamp is not centered	<i>Center the lamp</i>
	The lens (objective, condenser, eyepiece or collector) is dirty	<i>Clean it thoroughly</i>
Find dust and stain in the field of view	First rotate the eyepieces, if the dust moves:	<i>Clean the eyepieces</i>
	Next move the stage with slide, if the dust moves:	<i>Clean the slide or replace the slide</i>
	Next move the condenser up and down, if the dust moves (using 4 or 10x objective):	<i>Clean the top of the condenser</i>
	Next change objective, if the dirt is no longer visible:	<i>Clean the bottom lens of the objective</i>
	If problem remains:	<i>Clean the collector lens</i>
Image quality is not optimal (resolution or contrast)	There is no cover slip on the specimen	<i>Add cover slip</i>
	The cover slip is too thick or too thin	<i>Use the standard coverslip (0.17mm)</i>
	The specimen is placed upside down	<i>Turn slide around</i>
	There is oil on a non-oil lens, this often happens to the 40x objective	<i>Clean the objective</i>
	There are stains on the lens (including condenser, objective, eyepiece and collector)	<i>Clean the optical elements</i>
	No oil is used for the 100x oil objective	<i>Use Euromex immersion oil (PB.5255)</i>
	There are bubbles in the oil	<i>Try to remove the bubbles or create a new slide</i>
	Wrong oil is used	<i>Use Euromex immersion oil (PB.5255)</i>
	The size of the aperture diaphragm is too large	<i>Close the diaphragm</i>
	The size of the aperture diaphragm is too small	<i>Open the diaphragm</i>
Periphery of the image is dark/ unclear (unevenly illuminated)	The position of the condenser is too low	<i>Adjust the position</i>
	Diaphragm(s) closed too far	<i>Open the diaphragms</i>
	The nosepiece is not in the right position	<i>Turn the nosepiece until it "clicks" into position</i>
One side of the image is dark	The condenser is not centered correctly	<i>Center the condenser</i>
	The condenser is placed inclined in it's holder	<i>Install the condenser again and center it</i>
	The nosepiece is not in the right position	<i>Turn the condenser until it "clicks" into position</i>
	Diaphragm is not centered	<i>Center diaphragm</i>

One part of the image is not in focus. Part of the image becomes out of focus while moving specimen	The condenser is placed inclined in it's holder	<i>Install the condenser again and center it</i>
	The stage is tilted	<i>Re-install the stage making sure it is levelled</i>
	The specimen slide is not placed flat on the stage	<i>Replace the slide on the stage</i>
	The nosepiece is not in the right position	<i>Turn the nosepiece until it "clicks" into position</i>
Image can not be focused while stage is in highest position	The specimen slide is not prepared well	<i>Try a specimen of known quality and confirm</i>
	Focus lock system is secured at the wrong position	<i>Release the focus lock, focus and lock again</i>
The image through the eyepieces is shown as a double image or half moons appear	The stage is not installed correctly	<i>Re-install the stage making sure it is levelled</i>
	Interpupillary distance has not been set correctly	<i>Perform interpupillary adjustment</i>
Eyes are getting tired	Dioptr adjustment has not been done correctly	<i>Perform diopter adjustment</i>
	Brightness is not correct	<i>Adjust brightness using intensity control knob or filters</i>
	Interpupillary distance has not been set correctly	<i>Perform interpupillary adjustment</i>
The image is too dark	Dioptr adjustment has not been done correctly	<i>Perform diopter adjustment</i>
	Too low intensity set on intensity controller	<i>Increase the intensity by rotating the controller</i>
	The size of the aperture diaphragm is too small	<i>Adjust again</i>
	The position of the condenser is too low	<i>Adjust the position</i>
	Diaphragm(s) closed too far	<i>Open the diaphragms</i>
The image is too bright	The Köhler incident light is not in the centre	<i>Adjust the bolt of Köhler incident light</i>
	Too high intensity set on intensity controller	<i>Decrease the intensity by rotating the controller</i>
	The size of the aperture diaphragm is too large	<i>Adjust again</i>
The image cannot be focussed when using high magnification objectives	The position of the condenser is too high	<i>Adjust the position</i>
	The cover slip is too thick	<i>Use the standard coverslip (0.17 mm)</i>
	The specimen is placed upside down	<i>Turn slide around</i>
The objective touches the specimen when the magnification is being changed	Focus lock system is secured at the wrong position	<i>Release the focus lock, focus and lock again</i>
	The cover slip is too thick	<i>Use the standard coverslip (0.17 mm)</i>
Large focus deviation while changing objectives	Focus lock system is secured at the wrong position	<i>Release the focus lock, focus and lock again</i>
	An objective is placed incorrectly, not screwed in all the way	<i>Make sure the right objective is used and screw it all the way into the revolving nosepiece</i>
	The tension of the X/Y controls of the stage are set too tight	<i>Adjust tension to proper setting</i>
The slide does not move, or moves too heavily	Dioptr adjustment has not been done correctly	<i>Perform diopter adjustment</i>
	The specimen is not placed between the specimen holder	<i>Place specimen between the holder</i>
	The tension of the X/Y controls of the stage are set too tight	<i>Adjust tension to proper setting</i>



euromex.academy

