

Oxion Inverso

materials science



Contents

2. General safety instructions	3
2.1 Dangers associated with the operation	3
2.2 Photobiological safety LED, important safety instructions	3
2.3 Prevention of biological and infectious hazards	3
2.4 Disinfection and decontamination:	4
2.5 Environment, storage and use	5
3. Handling the microscope	5
4. Construction of the microscope	6
5. Safety signs	7
6 Assembly steps	7
6.1 Set the bulb	7
6.2 Assembling the light attachment	8
6.3 Assembling the objectives	8
6.4 Assembling the stage extension board/attachable mechanical stage	8
6.5 Assembling the metal stage	8
6.6 Assembling the eyepieces	8
6.7 Assembling the ground glass slider	8
6.8 Set the color filter or polarizer	9
6.9 Set the 360° rotating analyzer	9
7. Operation	9
7.1 Connecting power supply	9
7.2 Illumination	9
7.3 Place the sample	9
7.4 Shift the optical way	10
7.5 Focus	10
7.6 Adjusting the focusing tension	10
7.7 Adjusting the diopter	10
7.8 Adjusting the interpupillary distance	10
7.9 Using the eye-cap	10
7.10 Using the ground glass slider	11
7.11 Using the color filter	11
7.12 Adjusting the field diaphragm	11
7.13 Adjusting the aperture diaphragm	11
7.14 Centering the filament	11
7.15 Using the simple polarizing kits	12
7.16 Replacing the fuse	12
7.17 Mounting and using the c-mount adapters	12
8. Maintenance	12

1. Introduction

Oxion Inverso Metallurgical microscope is used for identification and analysis of metal internal organizational structure. It is an important role in the qualitative research of the foundry, smelting, heat treatment, raw materials, inspection or material handling aspects, post-analysis. It is an important tool for metal physics, it can also be applied for factories, mines and enterprises, universities and research sectors

Kindly note that some items described in this manual are optional accessories which are not supplied with the standard outfit of the microscope

2. General safety instructions

Intended use: a non-medical device

This microscope is intended for general observation of cells and tissues, with transmitted/reflected illumination and with the specimen fixed on a slide

2.1 Dangers associated with the operation

- Improper use could result in injury, malfunction or damage to property. It must be ensured that the operator informs every user of existing hazards
- Danger of electrocution. Disconnect the power to the entire lighting system before installing, adding or changing any component
- Not to be used in corrosive or explosive environments
- Avoid direct exposure of eyes to the collimated light beam or direct light from the light guides or fibres
- To avoid a hazard to children, account for all parts and keep all packing materials in a safe place

2.2 Photobiological safety LED, important safety instructions

- Avoid direct eye exposure to any LED light source while switched on
- Before looking through the eyepieces of the microscope, lower the intensity of the LED illumination
- Avoid long and high-intensity exposure to LED light because this may cause acute damage to the retina of the eye

2.3 Prevention of biological and infectious hazards

Infectious, bacterial or viral biohazard substances under observation may be a risk to the health of humans and other living organisms. Special precautions should be taken during in vitro medical procedures:

- **Biological hazards:** keep a logbook of all the biological substances or pathogenic microorganisms that were under observation with the microscope and show it to everybody before they use the microscope or before they do some maintenance work on the microscope! Agents can be bacterial, spores, enveloped or non-enveloped virus particles, fungi or protozoa
- **Contamination hazard:**
 - A sample that is properly enclosed with a cover glass never comes in direct contact with the microscope parts. In that case prevention of contamination lies in the handling of the slides; as long as the slides are decontaminated before use and are undamaged and treated normally, there is virtually zero risk of contamination
 - A sample that is mounted on a slide without cover glass, can come in contact with components of the microscope and may be a hazard to humans and/or the environment. Therefore, check the microscope and accessories on possible contaminations. Clean the microscope surfaces and its components as thoroughly as possible. Should you identify a possible contamination, inform the local responsible person in your organisation
 - Microscope operators could be contaminated from other activities and cross-contaminate components of the microscope. Therefore, check the microscope and accessories on possible contaminations. Clean the microscope surfaces and its components as thoroughly as possible. Should you identify a possible contamination, inform the local responsible person in your organisation. It is recommended to wear sterile gloves when preparing the slides and handling the microscope in order to reduce contamination by the operator
- **Infection hazard:** direct contact with the focusing knobs, stage adjustments, stage and eyepieces/tubes of the microscope can be a potential source of bacterial and/or viral infections. The risk can be limited by using personal eyeshades or eyepieces. You can also use personal protections such as operation gloves and/or safety goggles, which should be changed frequently to minimize the risk
- **Disinfectant hazards:** before cleaning or disinfecting, check if the room is adequately ventilated. If not, wear respiratory protective gear. Exposure to chemicals and aerosols can harm human eyes, skin and respiratory system. Do not inhale vapours. During disinfection, do not eat, drink or smoke. Used disinfectants must be disposed of according to local or national regulations for health and safety

2.4 Disinfection and decontamination:

- Exterior casing and mechanical surfaces must be wiped with a clean cloth, dampened with a disinfectant
- Soft plastic parts and rubber surfaces can be cleaned by gently wiping a clean cloth, dampened with a disinfectant. Discoloration can occur if alcohol is used
- The front lens of eyepieces and objectives are sensitive to chemicals. We recommend not to use aggressive disinfectants but to use lens paper or a soft fibre-free tissue, dampened in cleaning solution. Cotton swabs may also be used. We recommend you use personal eyepieces without eyeshades in order to minimize risk
- Never immerse or dip the eyepiece or objective into a disinfectant liquid! This will damage the component
- Never use abrasive compounds or cleaners that may damage and scratch optical coatings
- Properly clean and disinfect all possible contaminated surfaces of the microscope or contaminated accessories before storing for future use. Disinfection procedures must be effective and appropriate
- Leave the disinfectant on the surface for the required exposure time, as specified by the manufacturer. If the disinfectant evaporates before the full exposure time, reapply disinfectant on the surface
- For disinfection against bacteria, use a 70% aqueous solution of isopropanol (isopropyl alcohol) and apply for at least 30 seconds. Against viruses, we recommend to refer to specific alcohol or non-alcohol based disinfection products for laboratories

Before returning a microscope for repair or maintenance through a Euromex dealer, an RMA (return authorization form) together with a decontamination statement must be filled in! This document - available from Euromex for any reseller- must be shipped together with the microscope at all times

Reference documents:

World Health Organisation:

<https://www.who.int/ihr/publications/biosafety-video-series/en/>

Robert Koch Institut:

<https://link.springer.com/content/pdf/10.1007/s00103-013-1863-6.pdf>

US Centre for Disease Control and prevention

<https://www.cdc.gov/infectioncontrol/guidelines/disinfection/index.html>

Handle with care

- This product is a high quality optical instrument. Delicate handling is required
- Avoid subjecting it to sudden shocks and impacts
- Impacts, even small ones, can affect the precision of the instrument

Handling the LED

Note: Always disconnect the power cord from your microscope before handling the LED bulb and power unit and allow the system to cool down approximately 35 minutes to avoid burns

- Never touch the LED with your bare hands
- Dirt or fingerprints will reduce the life span and can result in uneven illumination, lowering the optical performance
- Use only original Euromex replacement LEDs
- The use of other products may cause malfunctions and will void warranty
- During use of the microscope the power unit will get hot; never touch it while in operation and allow the system to cool down approximately 35 minutes to avoid burns

Dirt on the lenses

- Dirt on or inside the optical components, such as eyepieces, lenses, etc., affects the image quality of your system negatively
- Always try to prevent your microscope from getting dirty by using the dust cover, prevent leaving fingerprints on the lenses and clean the outer surface of the lens regularly
- Cleaning optical components is a delicate matter. Please, read the cleaning instructions further on in this manual

2.5 Environment, storage and use

- This product is a precision instrument and it should be used in a proper environment for optimal use
- Install your product indoors on a stable, vibration free and level surface in order to prevent this instrument to fall thereby harming the operator
- Do not place the product in direct sunlight
- The ambient temperature should be between 5 to +40°C and humidity should be within 80% and 50%
- Although the system is anti-mold treated, installing this product in a hot, humid location may still result in the formation of mold or condensation on lenses, impairing performance or causing malfunctions
- Never turn the right and left focus knobs in opposite directions at the same time or turn the coarse focus knob past its farthest point as this will damage this product
- Never use undue force when turning the knobs
- Make sure that the microscope system can dissipate its heat (fire hazard)
- Keep the microscope away from walls and obstructions for at least approximately 15 cm
- Never turn the microscope on when the dust cover is in place or when items are placed on the microscope
- Keep flammable fluids, fabric, etc. well out of the way

Disconnect power

Always disconnect your microscope from power before doing any maintenance, cleaning, assembling or replacing LEDs to prevent electric shocks

Prevent contact with water and other fluids

Never allow water or other fluids to come in contact with your microscope, this can cause short circuiting your device, causing malfunction and damage to your system

Moving and assembling

- This microscope is a relatively heavy system, consider this when moving and installing the system
- Always lift the microscope by holding the main body and base of the microscope
- Never lift or move the microscope by its focusing knobs, stage or head
- When needed, move the microscope with two persons instead of one

3. Handling the microscope

- As the microscope is precision instruments, it should be handled carefully. Avoid impact during transportation
- Do not expose the microscope to direct sunlight, nor to high temperatures, damp, dust or acute shakes. Make sure the worktable is horizontal. Heed environmental conditions: indoor temperature: 5°C - 40°C, max. relative humidity: 80%
- To move the microscope, use one hand underneath the lower side of the observation tube (1), the other hand on the handle (2) and lift it carefully
- The lamp will be very hot while operating the microscope (3), please make sure there is enough space around to allow the heat to dissipate
- Please make sure the power switch (4) is "0"(Off) and the bulb cooled down before replacing the bulb or fuse

Bulb: 12V/50W halogen bulb (Philips 7027)



4. Construction of the microscope

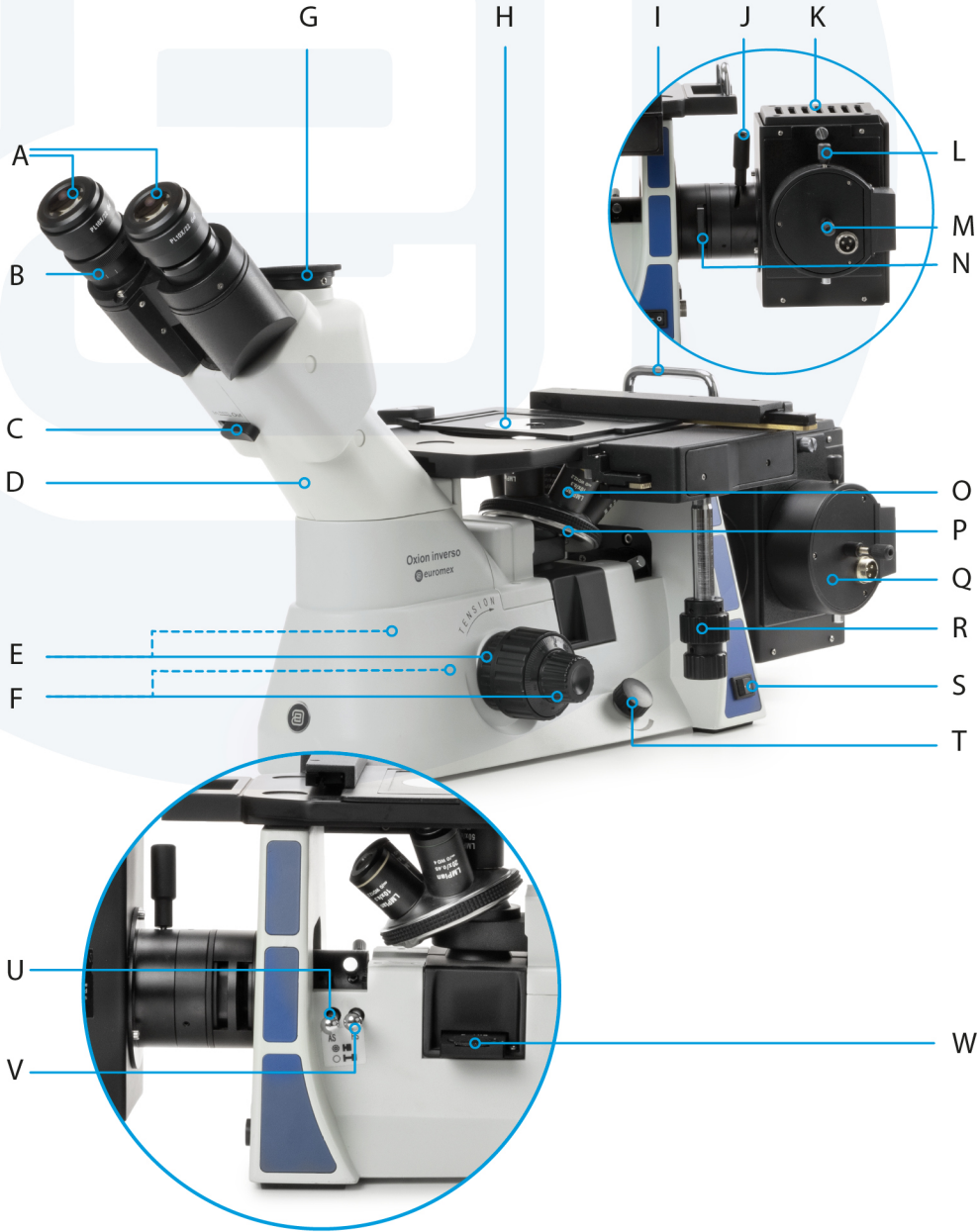



The names of the several parts are listed below and are indicated in the picture

A	Eyepieces
B	Diopter adjustment
C	Photo/video switch
D	Carrying position
E	Tension regulation
F	Coaxial coarse/fine focusing knobs
G	Photo port
H	Mechanical stage
I	Carrying handle
J	Focussing handle for bulb
K	Halogen bulb
L	Vertical bulb adjustment screw

M	Horizontal bulb adjustment screw
N	Frosted filter
O	Metallographic objectives
P	Revolving nosepiece
Q	Lamp unit
R	Mechanical stage control knobs
S	On/Off switch
T	Light intensity control
U	Aperture diaphragm rod
V	Field diaphragm rod
W	360° Rotating analyzer

5. Safety signs

Sign	Signification
	It shows the surface gets hot. Do not touch with bare hands
	Read the instruction before use. Unsuitable operation may lead to physical injury or instrument failure
	Power switch ON
O	Power switch OFF

6 Assembly steps

6.1 Set the bulb

- (Fig. 1) Loosen the lock-screw (1) completely by using a coin or a similar tool, rotate about 45° and take off the bulb holder (2)
- (Fig. 2) Hold the bulb (3) with clean gloves or gauze and insert the pins (4) to the jack (5). Make sure the bulb is vertical
- (Fig. 1) Put the bulb holder (2) in its housing and tighten the screw (1)
 - Standard bulb: 12V/50W halogen bulb, (Philips 7027)
 - In order to prevent the reduction of the lamp's life span and bulb burst, don't touch the bulb with your finger. If there is a fingerprint on it, clear it with clean gauze
 - Replacing the bulb during or after operation:
 - The bulb, bulb house and the immediate area are very hot. Before replacing the bulb, please set the power supply at "O" (OFF) and remove the power plug. Allow the instrument to cool down

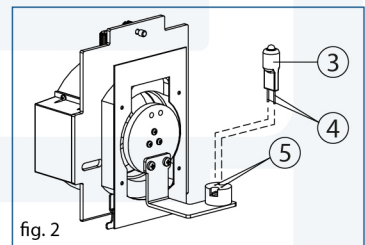
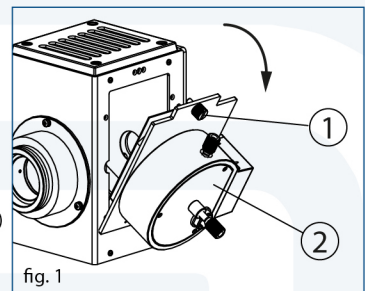

6.2 Assembling the light attachment

1. (Fig. 3) Loosen the lock-screw (1) with M4 inner hexagon spanner
 2. Insert the light attachment (2) into connector (3), and rotate until its upper plane (4) is horizontal, then tighten the screw (1) with M4 spanner
- During observation, please make sure there is enough space for heat dissipation around the bulb source, especially the upper and lower part of the bulb

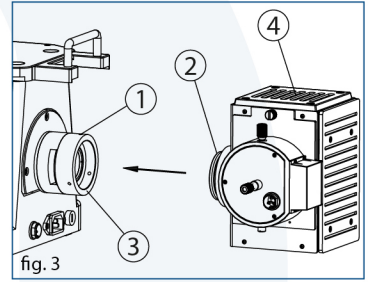

6.3 Assembling the objectives

1. (Fig. 4) Rotate the coarse focusing knob (1), until the nosepiece is in its lowest position
2. Install the objectives (2) into the microscope nosepiece, starting with the lowest magnification to the highest in a clockwise direction from the left or right side



Note:

Clean the objectives periodically

- Locate point of interest of the sample and focus by using a low magnification objective (5X or 10X). Then change to higher magnifications according to the observation requirements
- When changing the objectives, turn the nosepiece and make sure the objective clicks into place

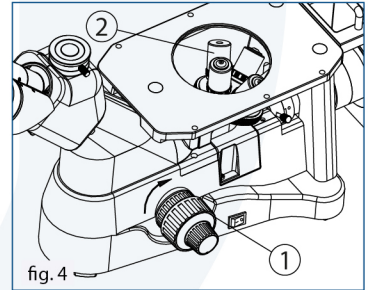

6.4 Assembling the stage extension board/attachable mechanical stage

1. (Fig. 5) Assembling the stage extension board
Unscrew the lock-screw(1) on the stage extension board, then screw it on bottom right or bottom left (2), and use small tools to tighten the screw until the board is fixed firmly
 2. Assembling attachable mechanical stage
Mount this the same way as the extension board
- Stage extension board can be mounted on both left and right to extend the work stage
 - The mechanical stage can only be mounted for right handed use

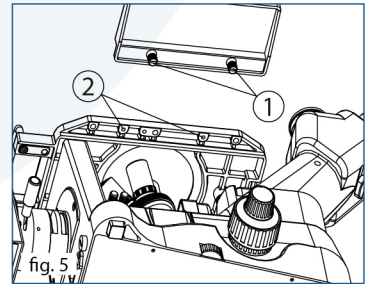

6.5 Assembling the metal stage

- (Fig. 6) Insert the metal stage (1) on the stage aperture

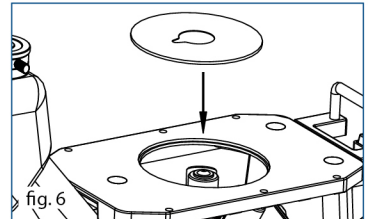

6.6 Assembling the eyepieces

1. (Fig. 7) Take off the cover (1) of eyepiece tube
2. Insert the eyepieces (2) thoroughly and gently into the tube

6.7 Assembling the ground glass slider

(Fig. 8) Screw off the one knob/screw (2) of the ground glass slider (1), insert the slider into the slot (3) of the connector until a "click" is heard, then reattach the knob/screw

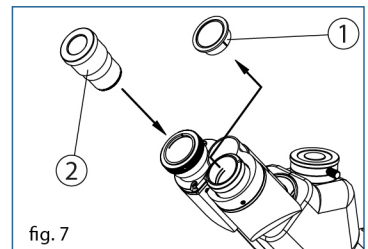

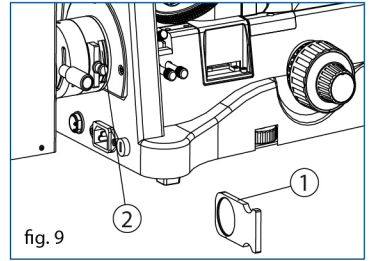
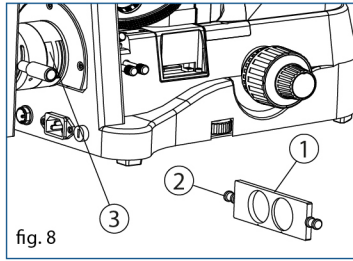

6.8 Set the color filter or polarizer

(Fig. 9) Insert the color filter board or the polarizer slider (1) into the slot of the connector (2) until a “click” is heard

6.9 Set the 360° rotating analyzer

(Fig. 10) Insert the analyzer with text-side up into the slot (2) until a “click” is heard

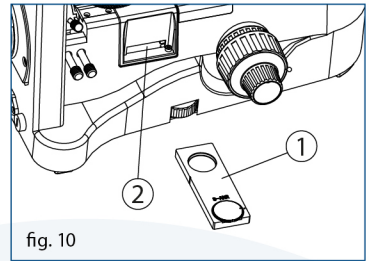

7. Operation

7.1 Connecting power supply

1. Ensure the main switch is on “O” (OFF)
2. (Fig. 11) Insert one side of the cable (1) to socket (2), and lock it with screw
3. Insert other side of the cable (1) to socket (3)
4. Insert the one side of the cable (4) to the microscope body power supply socket (5), other side to the socket of the power supply
 - Do not bend cable or plug to avoid damaging it
 - Please use the standard cable provided by our company. Use a similar one when missing or damaged
 - Connect the power supply correctly, be sure the instrument is grounded

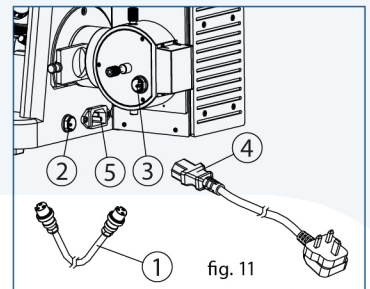

7.2 Illumination

1. Turn on the power supply, and put the power switch on (ON)
2. (Fig. 12) Turn the button (1) clockwise to increase light, and turn anticlockwise to decrease it
 - Use the bulb in low voltage to increase its life span

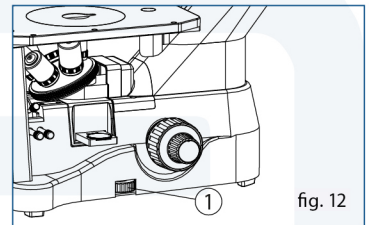

7.3 Place the sample

1. (Fig. 13) Place the sample in the center of the stage (1)
2. (Fig. 14, next page) In order to clip board of any type tightly, please use holder (3) and attachable mechanical stage (2), use the sample clip (4) to clip the holder (3), turn horizontally shift ring (5) and vertically shift ring (6) to shift the specimen to proper place. (Working distance range: 120 mm × 80 mm)

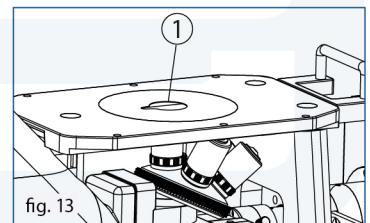

7.4 Shift the optical way

(Fig. 15) Using the lever, one can move the internal beam splitter to two different positions

- In one position, 20% of the light path goes through the eyepieces and 80% of the light path goes to the photo port
- In the second position, 100% of the light goes through the eyepieces

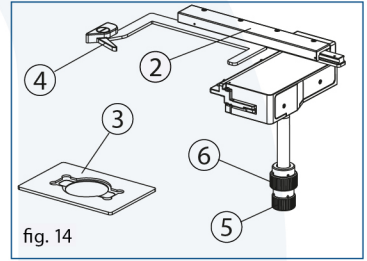

7.5 Focus

1. Place the sample on the stage, move the 5X objective into the light path. The surface of the placed sample should be positioned perpendicular to the objective. To prevent the sample from moving plasticine may be used
2. Adjust the diopter adjustment ring to "0", (see 3-6 Adjusting the diopter)

7.6 Adjusting the focusing tension

(Fig. 16) If focusing is too tight or too easy (the stage declines by itself) this problem can be solved by adjusting the tension adjustment ring; when turning the ring in the direction of the arrow the friction increases, in the opposite direction the friction decreases

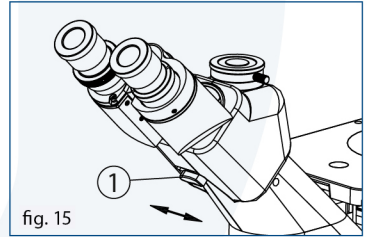

7.7 Adjusting the diopter

1. Adjust the diopter adjustment ring to "0"
2. Focus with both eyes on the specimen
3. Use left eye (right eye closed) and focus with (left) diopter adjustment
4. Take your eyes off the sample and turn back the diopter a few divisions
5. Reset your eyes by looking in the distance for a few seconds
6. Refocus with the left diopter, again using your left eye (right eye is closed)
7. Follow the same procedure for the right diopter adjustment
8. Remember your settings for future use

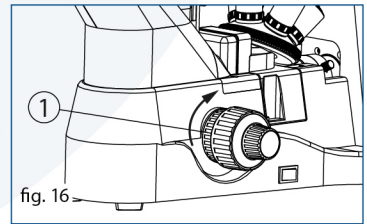

7.8 Adjusting the interpupillary distance

1. (Fig. 17) Use both eyes to observe, hold the base of the prism and rotate it around the axis until there is only one field of view
2. The "r" (1) on the side marks the position. The number is the interpupillary distance (2). Range: 50-75mm. Remembering your interpupillary distance may speed up your personal setup when you use the microscope next time

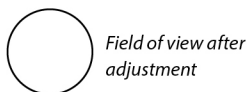
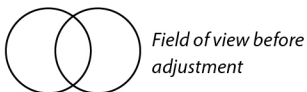
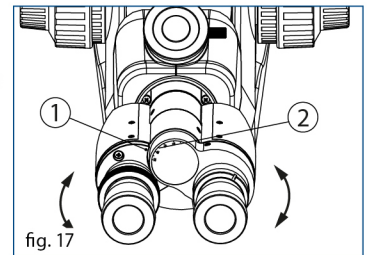

7.9 Using the eye-cap

1. (Fig. 18) If you wear glasses, turn over the eye-cap (1). It can prevent your glasses touching the eyepiece, thus avoiding damaging your glasses and the eyepieces
2. If you do not wear glasses, open the eye-cap (2). It can prevent stray light disturbing the observation

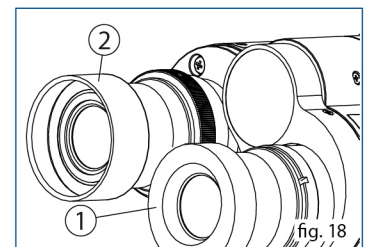

7.10 Using the ground glass slider

(Fig. 19) When putting the ground glass slider (1) in the left position the filament can be centered. When putting the slider in the right position the diffuse light causes the illumination to be uniform

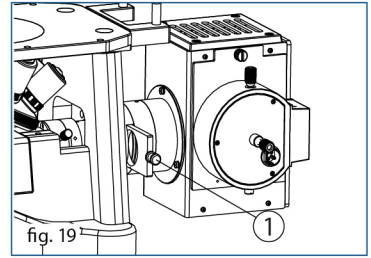

7.11 Using the color filter

(Fig. 20) A variety of filters can be inserted in slot. For example a daylight or frosted filter

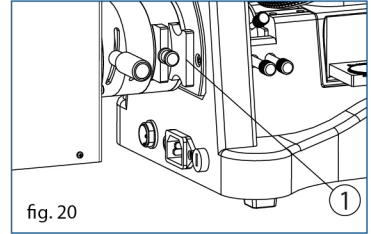

7.12 Adjusting the field diaphragm

By limiting the diameter of the beam entering the condenser, the field diaphragm can prevent stray light and avoid unnecessary optical aberrations. When the image of the field diaphragm is just outside the edge of the field of view, the best image can be obtained

1. (Fig. 21, 1) Pull rod to close the iris of the the field diaphragm
2. The image of the field diaphragm can be seen in the view of field through the eyepiece
3. Adjust the right and the left centering screws (2) on the field diaphragm until the image is centered
4. Open the field diaphragm gently (1). If the image in the diaphragm field is visible at the center of the view field, it means that the field diaphragm is properly centered (Fig. 22)
5. Enlarge the field diaphragm gently until just outside the view field

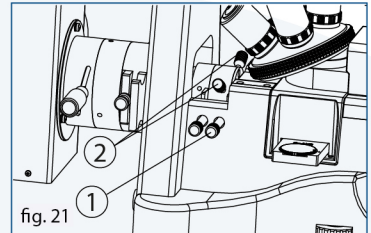

7.13 Adjusting the aperture diaphragm

- The aperture diaphragm influences the numerical aperture of the illumination. If the N.A. of the illumination matches with the N.A. of the objective, you can obtain better resolution and contrast, and increase the depth of field
- (Fig. 23) Adjusting the aperture diaphragm is done by using the lever (1)
- Adjust the size of the aperture diaphragm to your own preference

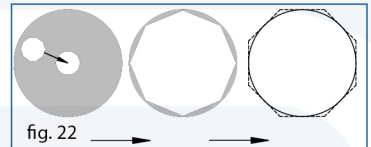

7.14 Centering the filament

(Fig. 24 and Fig. 25) Adjust the filament to the center of the field of view in order to get a uniform illumination

1. Pull the ground glass slider (1) out of the optical way until you hear a "click"
2. Push in the field diaphragm lever (4) and the aperture diaphragm lever (5)
3. Put a white piece of paper on the metal stage
4. Rotate the nosepiece to bring an empty hole into the light path. If there is a dust cap on the hole, remove it
5. Adjust the halogen bulb horizontal adjustment screw (2) and vertical adjustment screw (3). Find the filament image on the paper. Adjust the focus lock handle (6) to get a clear filament image. Then center it in the view field
6. Push the ground glass slider back into place. Then put a sample on the metal stage, adjust the focusing knob in order to get a clear image
7. Get the best view by adjusting the focus lock handle (6) while looking through the eyepieces, then lock it

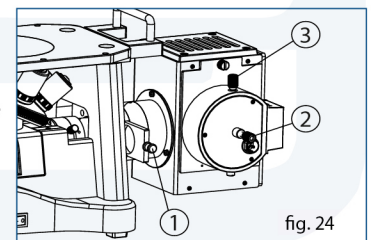
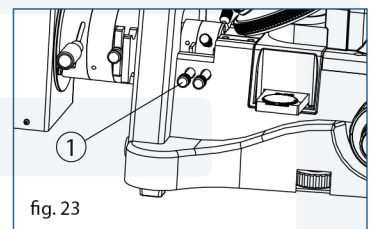

- Adjust the field diaphragm (4) and the aperture (5) to complete the procedure

7.15 Using the simple polarizing kit

(Fig. 26) The simple polarizing kit includes the polarizer (1) and the 360° rotating analyzer (2)

- Mount the polarizer and the 360° rotating analyzer (2) according to 6.8 and 6.9 (When using the polarizer, remove the color filter)
- Dialling the filter in the 360° rotating analyzer can change the state of the polarized light

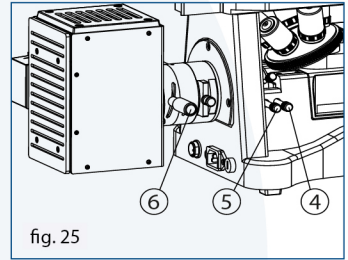

7.16 Replacing the fuse

(Fig. 27) Before replacing the fuse, please make sure the power switch is at "0" (Off) and remove cable from the socket. Use a screwdriver to take out the fuse (1) from the fuse holder (2) and replace with a new one

Fuse specifications: 250V, 3.15A

7.17 Mounting and using the c-mount adapters

- (Fig. 28) Loosen the lock-screw (1) on the photo tube and take off the cap (2)
- Take off the caps of c-mount adapter (3), place the adapter on the photo tube and lock by screw (1)
- Fix camera to c-mount (5)
- Adjust the image while looking through the eyepieces, then pull the light path shifting switch (7) to the left. Now you can observe the image produced by the camera. If it is not clear, you can adjust the length of the c-mount adapter (6) till the image is in focus

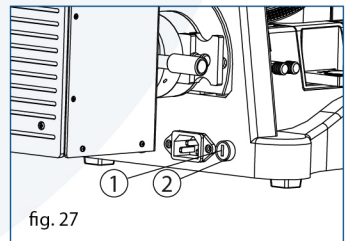
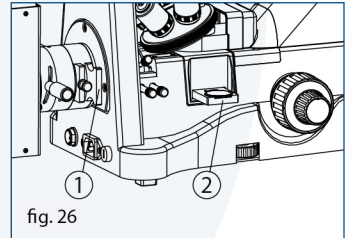

8. Maintenance

- Clean the lenses gently with a soft lens tissue. Carefully wipe off oil or fingerprints on the lens surfaces with tissue moistened with a 30/70 mixture of ethanol and aether or better isopropanol (as pure as possible)



Note: Ethanol and aether are both flammable. Please keep them away from fire or hot sources, especially when turning on or off the power switch

- Do not use organic solutions to clean the surfaces of the microscope, especially for plastic parts. Please use a neutral detergent if necessary
- If the microscope becomes damped by liquid during operation, please cut off the power immediately and dry the instrument
- Do not disassemble or assemble the microscope, in order to avoid damaging it
- After use, put a dust cover over the microscope to protect against dust

